

DC Inverter Air Source Heat Pumps (Monoblock Type)

1. Working source temperature range: -30°C to 45°C
2. Control Object: water tank temperature
(Setting range: Heating: $30^{\circ}\text{C} \sim 55^{\circ}\text{C}$; Cooling: $32^{\circ}\text{C} \sim 12^{\circ}\text{C}$)
3. Control Way: wire controller
4. Water Pump: start/stop according to water tank temp
5. Working Modes: hot water/heating/cooling/hot water+cooling/hot water+heating

SPRSUN



CGK015V3LB

CGK025V3L-B, CGK-025V3L-B
CGK030V3L-B, CGK-030V3L-B
CGK040V3L-B, CGK-040V3L-B



CGK050V3L-B, CGK-050V3L-B



CGK060V3L-B, CGK-060V3L-B



Guangzhou Sprsun New Energy Technology Development Co., Ltd.

R32 EVI DC Inverter Air Source Heat Pumps (Monoblock Type) with Colorful Touch Screen Controller



Smart WIFI Control

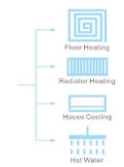
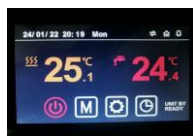

Model		CGK015V3L-B	CGK025V3L-B	CGK030V3L-B	CGK040V3L-B	CGK050V3L-B	CGK060V3L-B	CGK-025V3L-B	CGK-030V3L-B	CGK-040V3L-B	CGK-050V3L-B	CGK-060V3L-B	
Power Supply / Refrigerant	V/Hz/Ph	220-240/50/1 - R32	220-240/50/1 - R32	220-240/50/1 - R32	220-240/50/1 - R32	220-240/50/1 - R32	220-240/50/1 - R32	380-420/50/3 - R32	380-420/50/3 - R32	380-420/50/3 - R32	380-420/50/3 - R32	380-420/50/3 - R32	
Max. Heating Capacity (A7°C/W35°C)	kW	6	9,5	12	15	20	22	9,5	12	15	20	22	
C.O.P (A7°C/W35°C)	W/W	4,62	4,56	4,41	4,61	4,71	4,61	4,56	4,42	4,62	4,72	4,62	
Heating Capacity Min./Max.(A7°C/W35°C)	kW	2,76 / 6	4,37 / 9,50	5,52 / 12,00	6,90 / 15,00	9,20 / 20,00	10,12 / 22,00	4,37 / 9,50	5,52 / 12,00	6,90 / 15,00	9,20 / 20,00	10,12 / 22,00	
Heating Power Input Min./Max.(A7°C/W35°C)	W	478 / 1299	767 / 2083	1001 / 2721	1197 / 3254	1563 / 4246	1756 / 4772	767 / 2083	999 / 2715	1195 / 3247	1559 / 4237	1752 / 4762	
C.O.P Min./Max.(A7°C/W35°C)	W/W	4,62 / 5,78	4,56 / 5,70	4,41 / 5,51	4,61 / 5,76	4,71 / 5,89	4,61 / 5,76	4,56 / 5,70	4,42 / 5,53	4,62 / 5,78	4,72 / 5,90	4,62 / 5,78	
Max. Heating Capacity(A7°C/W45°C)	kW	5,8	9,1	11,5	14,4	19,2	21,1	9,1	11,5	14,4	19,2	21,1	
C.O.P (A7°C/W45°C)	W/W	3,70	3,65	3,53	3,69	3,77	3,69	3,65	3,54	3,70	3,78	3,70	
Heating Capacity Min./Max.(A7°C/W45°C)	kW	2,65 / 5,76	4,20 / 9,12	5,30 / 11,52	6,62 / 14,40	8,83 / 19,20	9,72 / 21,12	4,20 / 9,12	5,30 / 11,52	6,62 / 14,40	8,83 / 19,20	9,72 / 21,12	
Heating power input Min./Max.(A7°C/W45°C)	W	604 / 1558	968 / 2500	1265 / 3265	1513 / 3905	1974 / 5096	2218 / 5727	968 / 2500	1262 / 3258	1509 / 3896	1970 / 5085	2214 / 5714	
C.O.P Min./Max.(A7°C/W45°C)	W/W	3,70 / 4,39	3,65 / 4,33	3,53 / 4,19	3,69 / 4,38	3,77 / 4,47	3,69 / 4,38	3,65 / 4,33	3,54 / 4,20	3,70 / 4,39	3,78 / 4,48	3,70 / 4,39	
Max. Cooling Capacity(A35°C/W18°C)	kW	5,5	8,7	10,9	13,7	18,2	20,1	8,7	10,9	13,7	18,2	20,1	
E.E.R (A35°C/W18°C)	W/W	3,59	3,54	3,42	3,58	3,65	3,58	3,54	3,43	3,59	3,66	3,59	
Cooling Capacity Min./Max.(A35°C/W18°C)	kW	2,52 / 5,47	3,99 / 8,66	5,03 / 10,94	6,29 / 13,68	8,39 / 18,24	9,23 / 20,06	3,99 / 8,66	5,03 / 10,94	6,29 / 13,68	8,39 / 18,24	9,23 / 20,06	
Cooling Power Input Min./Max.(A35°C/W18°C)	W	585 / 1784	939 / 2448	1226 / 3198	1466 / 3824	1913 / 4990	2150 / 5609	939 / 2448	1223 / 3191	1463 / 3816	1909 / 4980	2146 / 5596	
E.E.R Min./Max.(A35°C/W18°C)	W/W	3,07 / 4,30	3,54 / 4,25	3,42 / 4,11	3,58 / 4,29	3,65 / 4,39	3,58 / 4,29	3,54 / 4,25	3,43 / 4,12	3,59 / 4,30	3,66 / 4,39	3,59 / 4,30	
Max. Cooling Capacity(A35°C/W7°C)	kW	4,3	6,1	7,7	9,6	12,9	14,2	6,1	7,7	9,6	12,9	14,2	
E.E.R(A35°C/W7°C)	W/W	2,69	2,48	2,40	2,50	2,56	2,50	2,48	2,40	2,51	2,56	2,51	
Cooling Capacity Min./Max.(A35°C/W7°C)	kW	1,99 / 4,32	2,81 / 6,11	3,55 / 7,72	4,44 / 9,65	5,92 / 12,86	6,51 / 14,15	2,81 / 6,11	3,55 / 7,72	4,44 / 9,65	5,92 / 12,86	6,51 / 14,15	
Cooling Power Input Min./Max.(A35°C/W7°C)	W	525 / 1657	752 / 2467	983 / 3222	1175 / 3853	1533 / 5028	1723 / 5651	752 / 2467	980 / 3215	1173 / 3844	1530 / 5017	1720 / 5639	
E.E.R Min./Max.(A35°C/W7°C)	W/W	2,61 / 3,79	2,48 / 3,74	2,40 / 3,61	2,50 / 3,78	2,56 / 3,86	2,50 / 3,78	2,48 / 3,74	2,40 / 3,62	2,51 / 3,79	2,56 / 3,87	2,51 / 3,79	
Max Power Input	kW	1,9	3,13	4,08	4,88	6,37	7,16	3,13	4,07	4,87	6,36	7,14	
Max Current	A	9,0	14,95	19,53	23,35	30,48	34,25	6,59	8,59	10,28	13,41	15,07	
Compressor	Type - Quantity/System	Twin Rotary - 1											
	Quantity	1											
Fan	Airflow	1500	2500	3000	3500	5000	5500	2500	3000	3500	5000	5500	
	Rated power	30	80	100	120	200	210	80	100	120	200	210	
	Type	Plate Heat Exchanger											
Water Side Heat Exchanger	Water Pressure Drop	18		18		20		21		23		25	
	Piping Connection	G3/4"		G1"		G1"		G1"		G1"		G1"	
Allowable Water Flow	Min./Rated./Max.	0,18	0,29	0,48	0,28	0,45	0,76	0,36	0,57	0,96	0,45	0,72	1,19
Noise Level	dB(A)	49,00		56		59		61		62		62	
Net Dimension(LxDxH)	mm	990*375*655		1110*475*810		1110*475*810		1110*475*960		1110*475*1355		1110*475*1355	
Packing Dimension(LxDxH)	mm	1070*405*800		1200*540*970		1200*540*970		1200*540*1120		1200*540*1510		1200*540*1510	
Net Weight	kg	52		78		88		98		124		124	
Gross Weight	kg	58		106		116		126		161		161	

Note: (1) Heating condition: water inlet/outlet temperature: 30°C/35°C, Ambient temperature: DB 7°C/WB 6°C;

(2) Heating condition: water inlet/outlet temperature: 40°C/45°C, Ambient temperature: DB 7°C/WB 6°C;

(3) Cooling condition: water inlet/outlet temperature: 23°C/18°C, Ambient temperature: DB35°C/WB24°C;

(4) Cooling condition: water inlet/outlet temperature: 12°C/7°C, Ambient temperature: DB35°C/WB24°C;

Heating Capacity at Different Conditions



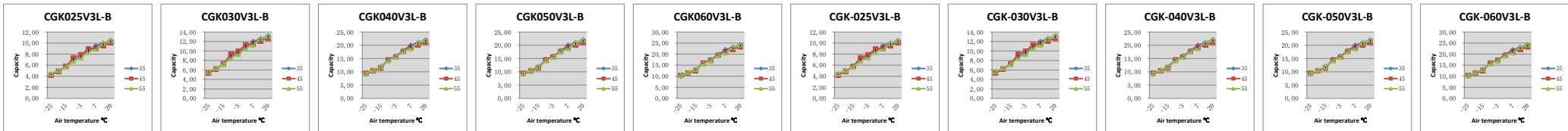



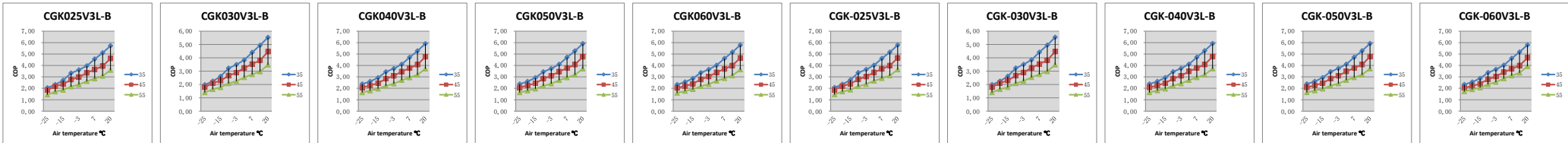

Model	CGK025V3L-B			CGK030V3L-B			CGK040V3L-B			CGK050V3L-B			CGK060V3L-B			CGK-025V3L-B			CGK-030V3L-B			CGK-040V3L-B			CGK-050V3L-B			CGK-060V3L-B		
Air temp °C	Heating capacity (KW)									Heating capacity (KW)									Heating capacity (KW)											
-25	4.30	4.23	4.50	5.43	5.35	5.69	6.86	7.11	7.11	9.15	9.48	9.48	10.07	10.42	10.43	4.30	4.23	4.50	5.43	5.35	5.69	6.86	7.11	7.11	9.15	9.48	9.48	10.07	10.42	10.43
-20	4.94	4.92	5.08	6.24	6.22	6.41	7.80	7.81	8.02	10.40	10.41	10.69	11.44	11.45	11.76	4.94	4.92	5.08	6.24	6.22	6.41	7.80	7.81	8.02	10.40	10.41	10.69	11.44	11.45	11.76
-15	5.68	5.79	5.69	7.17	7.31	7.18	8.97	8.58	8.98	11.96	11.44	11.97	13.15	12.59	13.17	5.68	5.79	5.69	7.17	7.31	7.18	8.97	8.58	8.98	11.96	11.44	11.97	13.15	12.59	13.17
-7	6.93	7.33	6.76	8.75	9.26	8.54	10.94	10.86	10.67	14.58	14.48	14.23	16.04	15.93	15.66	6.93	7.33	6.76	8.75	9.26	8.54	10.94	10.86	10.67	14.58	14.48	14.23	16.04	15.93	15.66
-3	7.54	7.88	7.37	9.53	9.96	9.31	11.91	11.68	11.64	15.88	15.58	15.52	17.46	17.14	17.07	7.54	7.88	7.37	9.53	9.96	9.31	11.91	11.68	11.64	15.88	15.58	15.52	17.46	17.14	17.07
2	8.55	8.94	8.36	10.80	11.29	10.56	13.50	13.25	13.19	18.00	17.66	17.59	19.80	19.43	19.35	8.55	8.94	8.36	10.80	11.29	10.56	13.50	13.25	13.19	18.00	17.66	17.59	19.80	19.43	19.35
7	9.50	9.12	8.94	12.00	11.52	11.29	15.00	14.40	14.11	20.00	19.20	18.82	22.00	21.12	20.70	9.50	9.12	8.94	12.00	11.52	11.29	15.00	14.40	14.11	20.00	19.20	18.82	22.00	21.12	20.70
12	9.98	9.58	9.99	12.60	12.10	12.62	15.75	15.12	15.78	21.00	20.16	21.04	23.10	22.18	23.14	9.98	9.58	9.99	12.60	12.10	12.62	15.75	15.12	15.78	21.00	20.16	21.04	23.10	22.18	23.14
20	10.47	10.05	10.48	13.23	12.70	13.24	16.54	15.88	16.55	22.05	21.17	22.07	24.26	23.28	24.27	10.47	10.05	10.48	13.23	12.70	13.24	16.54	15.88	16.55	22.05	21.17	22.07	24.26	23.28	24.27
Hot water temp °C	30/35	40/45	50/55	30/35	40/45	50/55	30/35	40/45	50/55	30/35	40/45	50/55	30/35	40/45	50/55	30/35	40/45	50/55	30/35	40/45	50/55	30/35	40/45	50/55	30/35	40/45	50/55	30/35	40/45	50/55

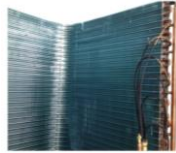









Model	CGK025V3L-B			CGK030V3L-B			CGK040V3L-B			CGK050V3L-B			CGK060V3L-B			CGK-025V3L-B			CGK-030V3L-B			CGK-040V3L-B			CGK-050V3L-B			CGK-060V3L-B		
Air temp °C	COP kW/kW									COP kW/kW									COP kW/kW											
-25	2.04	1.85	1.44	1.98	1.79	1.40	2.32	2.03	1.60	2.37	2.07	1.63	2.32	2.03	1.60	2.07	1.87	1.46	1.98	1.79	1.40	2.32	2.03	1.60	2.37	2.07	1.63	2.32	2.03	1.60
-20	2.32	2.18	1.70	2.25	2.11	1.64	2.55	2.20	1.76	2.60	2.35	1.80	2.55	2.20	1.76	2.35	2.20	1.72	2.25	2.11	1.65	2.55	2.21	1.76	2.61	2.25	1.80	2.55	2.21	1.90
-15	2.70	2.37	1.85	2.61	2.29	1.79	2.86	2.39	1.91	2.93	2.44	1.95	2.86	2.39	1.91	2.73	2.39	1.87	2.62	2.29	1.79	2.87	2.40	1.91	2.93	2.45	1.96	2.87	2.40	2.06
-7	3.33	2.75	2.15	3.22	2.66	2.08	3.37	2.78	2.17	3.44	2.84	2.22	3.37	2.78	2.17	3.37	2.78	2.17	3.23	2.67	2.08	3.38	2.79	2.17	3.45	2.85	2.22	3.38	2.79	2.34
-3	3.61	2.99	2.33	3.49	2.89	2.25	3.65	3.02	2.36	3.73	3.09	2.41	3.65	3.02	2.36	3.65	3.02	2.36	3.50	2.90	2.26	3.66	3.03	2.36	3.74	3.09	2.41	3.66	3.03	2.54
2	3.97	3.36	2.62	3.84	3.25	2.53	4.01	3.39	2.65	4.10	3.47	2.70	4.01	3.39	2.65	4.01	3.39	2.65	3.85	3.25	2.54	4.02	3.40	2.65	4.11	3.47	2.71	4.02	3.40	2.86
7	4.56	3.65	2.85	4.41	3.53	2.75	4.61	3.69	2.88	4.71	3.77	2.94	4.61	3.69	2.88	4.61	3.69	2.88	4.42	3.54	2.76	4.62	3.70	2.88	4.72	3.78	2.95	4.62	3.70	3.10
12	5.11	3.94	3.07	4.94	3.81	2.97	5.16	3.98	3.11	5.28	4.07	3.17	5.16	3.98	3.11	5.16	3.98	3.11	4.95	3.82	2.98	5.17	3.99	3.11	5.29	4.08	3.18	5.17	3.99	3.35
20	5.72	4.61	3.60	5.53	4.46	3.48	5.78	4.66	3.63	5.91	4.76	3.71	5.78	4.66	3.63	5.78	4.66	3.63	5.54	4.47	3.49	5.80	4.67	3.64	5.92	4.77	3.72	5.80	4.67	3.92
Hot water temp °C	35	45	55	35	45	55	35	45	55	35	45	55	35	45	55	35	45	55	35	45	55	35	45	55	35	45	55	35	45	55



Standard Materials

Name	Description	Picture	Name	Description	Picture	Name	Description	Picture
Condenser	Plate Heat Exchanger		Evaporator	Hydropilic Aluminium foil and internal thread copper pipe heat exchanger		High Pressure Sensor	Manqiwei 0-4.5MPa	
Compressor	Panasonic Rotary Compressor		Expansion Valve	Danfoss Electronic expansion valve		Low Pressure Sensor	Manqiwei 0-3.45MPa	
4-way valve	SANHUA		DC Fan	NIDEC DC Fan		Package	corrugated board case / plywood case	
Controller	Touch screen Controller							

Installation Diagram

Symbol	Name
	3-way valve
	2-way valve
	Ball valve
	Non-return valve
	Filter
	Water pump
	Temp sensor
	Release valve
	Expansion tank

Notice:

1. Pls select the right modes according to your demand then install it according to the installation diagram. If only hot water function required, pls select heating+hot water mode , and then put the hot water sensor into the hot water tank.
2. Two-way valve and BV valve are optional for installation. Only If you need to control the temperature by different zone, then pls install both.
3. Fan coil can be controlled by linkage with the secondary circulation pump . Meanwhile, a passive linkage thermostat shall be installed.

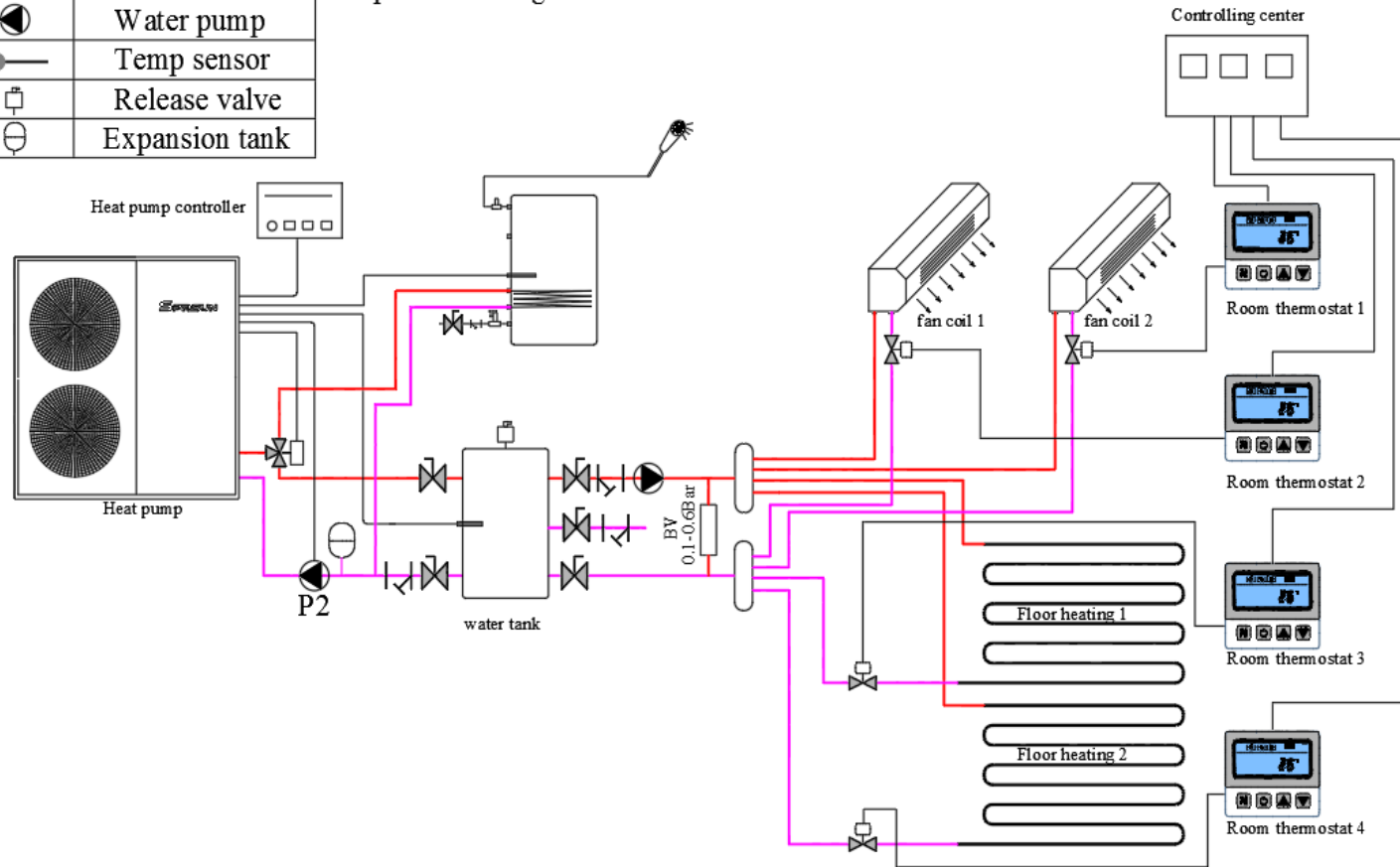

SPRSUN DC inverter air source heat pump

Functions

1. Defrost operation

λ Heating or hot water enters defrost conditions:

When heating or hot water, the accumulative running time of the compressor is ≥ 45 min (parameter P10), and the continuous running time of the compressor is ≥ 5 min;

Outer coil temperature $< -3^{\circ}\text{C}$ (parameter P11);

① (ambient temperature - outer coil temperature) $\geq 5^{\circ}\text{C}$ (parameter P14), and $-7^{\circ}\text{C} \leq$ ambient temperature \leq parameter P16 for 30 seconds;

② (ambient temperature - outer coil temperature) $\geq 5^{\circ}\text{C}$ (parameter P15), and ambient temperature $< -7^{\circ}\text{C}$ for 30 seconds;

When the above conditions are met at the same time, the defrost is entered; (Note: ① and ② only need to meet either condition)

When the temperature of the outer coil fails, if the ambient temperature is less than or equal to 20°C , the defrost will be changed to a regular defrost, and the defrost time is 10MIN;

λ Entering defrost conditions at startup:

When the shutdown/standby/press power-off time is greater than or equal to 30min;

$-7^{\circ}\text{C} \leq$ ambient temperature $\leq 3^{\circ}\text{C}$, and coil temperature $< -3^{\circ}\text{C}$ (parameter P11);

When the compressor start-up conditions are met (the water temperature is lower than the return difference / the machine is turned on to start, but not started), enter when the above conditions are met

Defrost runs.

λ Exit defrost condition:

After 2 minutes of defrosting, when the temperature of the outer coil is greater than or equal to 20°C (parameter P13) or the defrosting time reaches 10MIN (parameter P12), the system will exit the defrosting;

λ Defrosting action: (the compressor is not turned off when defrosting, but the frequency is reduced to a minimum of 30Hz)

When the defrosting conditions are met, the following actions are performed:

- 1) The compressor drops to 30Hz, and the fan turns off after 15 seconds;
- 2) The four-way valve is powered on at 55S;
- 3) At 60S, the compressor will rise to the defrosting frequency of 60Hz (parameter P09);
- 4) The water pump keeps running;

When the exit defrost condition is met, the following actions are performed:

- 1) Press down to 30Hz;
- 2) The four-way valve loses power at 55S;
- 3) At 60S, the fan is turned on, and after 5 seconds, the compressor returns to the normal control frequency and resumes normal operation;

λ Abnormal end of defrost:

- 1) When a fault protection shutdown occurs during defrosting, the system immediately exits defrosting and stops running;
- 2) Low voltage protection is not detected during defrosting;

Forced defrost: When the temperature of the outer coil is lower than the exit defrost temperature, long press the "Function" + "-" button for 3 seconds to enter the forced defrost.

2. Heating electric heating

λ The control logic is as follows:

vStart condition:

- 1) In heating mode;
- 2) Ambient temperature $< 10^{\circ}\text{C}$ (F59) or ambient temperature sensor failure
- 3) There is a demand for heating, that is, when the inlet water temperature \leq heating set temperature - air conditioning return temperature (parameter P01);
- 4) The water pump is running
- 5) 5 minutes after the press starts (F57);

When the above conditions are met at the same time, the electric auxiliary heat is turned on.

vClose condition:

- 1) Cooling mode, hot water mode;
- 2) When there is no demand for heating or constant temperature control;
- 3) The water inlet temperature sensor malfunction alarm;
- 4) Ambient temperature $> 10^{\circ}\text{C}$ (F59)
- 5) Water flow failure
- 6) The water pump is turned off

When any of the above conditions are met, the electric auxiliary heating stops

λ When the electric auxiliary heating is turned on, the water pump is turned on 30s in advance; when the auxiliary electric heating is turned off, the water pump is turned off after a delay of 30s.

λ When defrosting, forced defrosting, and secondary antifreeze, the electric heating is forced to be turned on;

When the high pressure fault, low pressure fault, exhaust temperature sensing fault, and exhaust gas high protection stop, if the compressor cannot be started after locking, the electric heating will be started to replace the compressor running after 5 minutes.

3. Hot water electric heating

λ The control logic is as follows:

vStart condition:

- 1) In hot water mode;
- 2) Ambient temperature $< 10^{\circ}\text{C}$ (F58) or ambient temperature sensor failure
- 3) There is a demand for hot water, that is, when the temperature of the water tank is less than or equal to the set temperature of the hot water - the return difference temperature of the hot water (parameter P02);
- 4) 5 minutes after the press starts (F56);

When the above conditions are met at the same time, the electric auxiliary heat is turned on.

vClose condition:

- 1) Cooling mode, heating mode;
- 2) When there is no demand for hot water or constant temperature control;
- 3) The water tank temperature sensor has a fault alarm;
- 4) Ambient temperature $> 10^{\circ}\text{C}$ (F58)

When any of the above conditions are met, the electric auxiliary heating stops

λ When defrosting, forced defrosting, and secondary antifreeze, the electric heating is forced to be turned on;

When the high pressure fault, low pressure fault, exhaust temperature sensing fault, and exhaust gas high protection shutdown, if the compressor cannot be started after locking, the electric heating will be started to replace the compressor running after 5 minutes.